

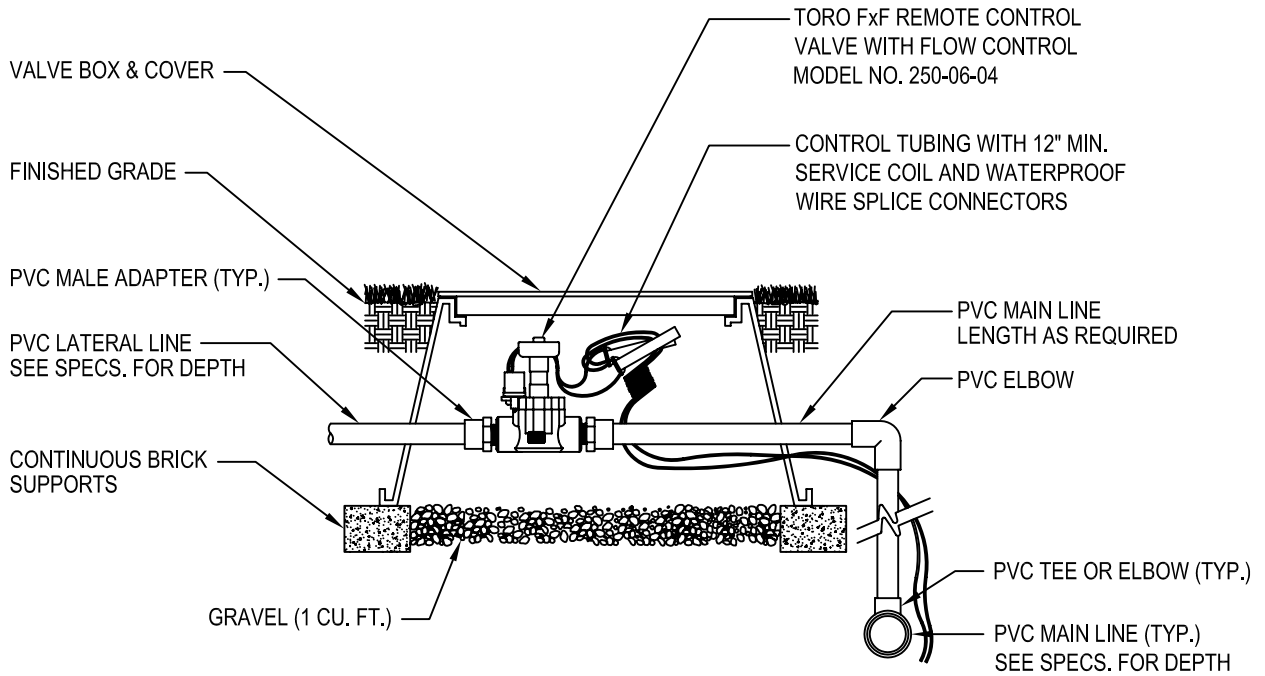

TORO-IRRIGATION DIVISION
 5825 JASMINE STREET
 RIVERSIDE, CA 92504
 TOLL FREE: 1-800-664-4740
 PHONE: (951) 785-3152
 FAX: (951) 359-1870
 www.toro.com



SECTION/ELEVATION
 NOT TO SCALE

NOTES:

1. INSTALLATION TO BE COMPLETED IN ACCORDANCE WITH MANUFACTURERS SPECIFICATIONS.
2. DO NOT SCALE DRAWINGS.
3. CONTRACTORS NOTE: FOR PRODUCT AND COMPANY INFORMATION VISIT www.CADdetails.com/info REFERENCE NUMBER 065-54.

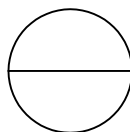

VALVES: 250 SERIES

1" PLASTIC VALVE, FxF